Comfort-Cire®

Century®

PARTS LIST

**Inverter Single Zone
Indoor Ductless Mini-Split**

B-VMH09SV-1

EXPLODED VIEW

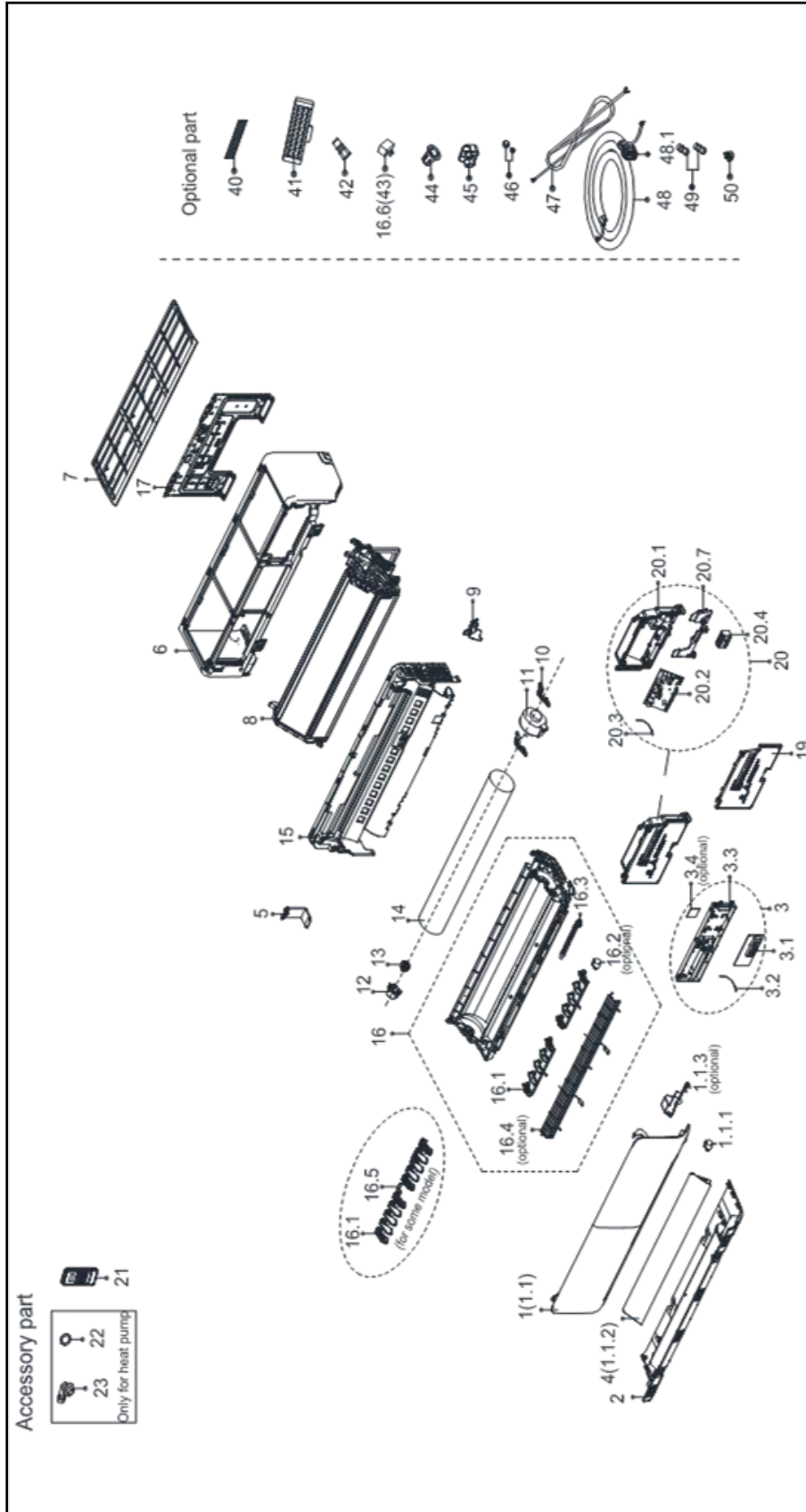

REPLACEMENT PARTS

Location	Part Name	Quantity	Part No.
1	Panel assembly	1	12122000026983
2	Horizontal louver	1	12122000026607
3	Display box subassembly	1	17222000A63824
3.1	Display board subassembly	1	17122000050213
3.2	Room Temperature Sensor	1	11201007003103
3.3	Display box	1	12122000026921
5	Chassis support I	1	12122000026621
6	Panel frame assembly	1	12122000A85083
7	Filter filter subassembly	1	12122000026428
8	Evaporator assembly	1	15822000A18343
9	pipe clamp board	1	12122000026609
10	Fixing board of fan motor	2	12122000011994
11	Brushless DC Motor	1	11002015000051
12	Bearing holder	1	12122000000350
13	Bearing components	1	12622000000131
14	Cross flow fan	1	12100102000696
15	Chassis assembly(above)	1	12122000026603
16	Chassis assembly(below)	1	12122000028661
16.1	Horizontal louver	4	12122000026617
16.1	Horizontal louver	6	12122000026616
16.2	Stepper motor	1	11002010001486
16.3	Drain hose	1	12100501000032
16.4	Protective wire	1	12922000001991
16.5	Connecting rod of louver	1	12122000026618
17	Installation plate subassembly	1	12222000A06973
19	Cover of electronic control box subassembly	1	12122000026601
20	Electronic control box subassembly (Mid-and low-end)	1	17222000032943
20.1	Electronic control box subassembly	1	12122000026606
20.2	Main control board subassembly	1	17122000050501
20.3	Pipe Temperature Sensor	1	11201007003445
20.4	Wire joint	1	17400401000577
20.7	Electrical Control Box holder	1	12122000026605
21	Remote controller	1	17317000A63584
22	seal ring	1	12600701000039
23	Drain hose	1	12100509000061
40	Air freshening filter	2	12100206000056
42	Check valve	1	15500209000001
45	Bracket of remote Controller	1	12122000029201
46	Copper nut	1	15500406000010
46	Copper nut	1	15500406000016

Due to ongoing product improvements, specifications and dimensions are subject to change and correction without notice or incurring obligations. Determining the application and suitability for use of any product is the responsibility of the installer. Additionally, the installer is responsible for verifying dimensional data on the actual product prior to beginning any installation preparations.

Incentive and rebate programs have precise requirements as to product performance and certification. All products meet applicable regulations in effect on date of manufacture; however, certifications are not necessarily granted for the life of a product. Therefore, it is the responsibility of the applicant to determine whether a specific model qualifies for these incentive/rebate programs.



1900 Wellworth Ave., Jackson, MI 49203 • Ph. 517-787-2100 • www.comfort-aire.com • www.century-hvac.com



www.marsdelivers.com • www.heatcontroller.com